

Low Signal Relay G6E

Subminiature, Sensitive Signal Relay

- Subminiature 7.87 H x 9.91 W x 16 L mm.
- High sensitivity with pick-up coil power of 98 mW.
- Surge withstand voltage meets FCC Part 68 requirements.
- Unique moving loop armature reduces relay size, magnetic interference, and contact bounce time.
- Bifurcated crossbar contact assures high reliability.
- Single and Dual coil latching versions available.
- Fully sealed construction.
- RoHS Compliant.

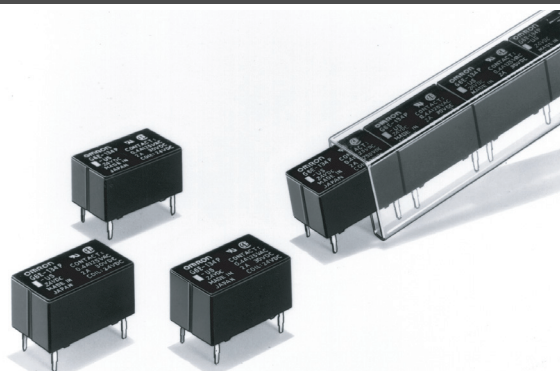

Ordering Information

To Order: Select the part number and add the desired coil voltage rating, (e.g., G6E-134P-ST-US-DC6).

Contact form		Model			
		Terminal style	Standard	Single coil latching	Dual coil latching
SPDT	Bifurcated crossbar	Straight	G6E-134P-US	G6EU-134P-US	G6EK-134P-US
		Self-clinching	G6E-134C-US	G6EU-134C-US	G6EK-134C-US

Model Number Legend

G6E - - - DC
 1 2 3 4 5 6 7 8 9

- | | | | |
|--|--|---|--|
| <p>1. Relay Function
 None: Single-side stable
 U: Single-winding latching
 K: Double-winding latching</p> <p>2. Contact Form
 1: SPDT</p> | <p>3. Contact Type
 3: Bifurcated crossbar
 Ag (Au-Alloy) contact</p> <p>4. Enclosure Ratings
 4: Fully sealed</p> | <p>5. Terminals
 P: Straight PCB
 C: Curved tail</p> <p>6. Special Function
 L: Low sensitivity coil (400 mW)</p> | <p>7. Standoff dimension
 Blank: 0.3 mm
 ST: 0.64 mm</p> <p>8. Approved Standards
 US: UL, CSA certified</p> <p>9. Rated Coil Voltage
 3, 5, 6, 9, 12, 24, 48 VDC</p> |
|--|--|---|--|

Specifications

Contact Data

Load	Resistive load (p.f. = 1)	Inductive load (p.f. = 0.4) (L/R = 7 ms)
Rated load	0.40 A at 125 VAC, 2 A at 30 VDC	0.20 A at 125 VAC, 1 A at 30 VDC
Contact material	Ag (Au clad)	
Carry current	3 A	
Max. operating voltage	250 VAC, 220 VDC	
Max. operating current	3 A	
Max. switching capacity	50 VA, 60 W	25 VA, 30 W
Min. permissible load (See note)	10 μA, 10 mVDC	

Note: P level: $\lambda_{60} = 0.1 \times 10^{-6}$ /operation
 This value was measured at a switching frequency of 120 operations/min and the criterion of contact resistance is 50 Ω. This value may vary depending on the switching frequency and operating environment. Always double-check relay suitability under actual operating conditions.

■ Coil Data

Standard Non-latching Type (G6E-134P(-ST)-US, G6E-134C(-ST)-US)

Rated voltage (VDC)	Rated current (mA)	Coil resistance (Ω)	Coil inductance (ref. value) (H)		Pick-up voltage	Dropout voltage	Maximum voltage	Power consumption (mW)
			Armature OFF	Armature ON				
3	66.70	45	0.08	0.06	70% max.	10% min.	190% at 23°C	Approx. 200
5	40	125	0.18	0.17				
6	33.30	180	0.31	0.24				
9	22.20	405	0.62	0.50				
12	16.70	720	1.20	0.99				
24	8.30	2,880	4.70	3.90				
48	8.30	5,760	5.35	5.12	170% at 23°C	Approx. 400		

Low-sensitivity Non-latching Type (G6E-134PL(-ST)-US)

Rated voltage (VDC)	Rated current (mA)	Coil resistance (Ω)	Coil inductance (ref. value) (H)		Pick-up voltage	Dropout voltage	Maximum voltage	Power consumption (mW)
			Armature OFF	Armature ON				
3	133	22.50	0.03	0.03	70% max.	10% min.	190% at 23°C	Approx. 400
5	79.40	63	0.08	0.07				
6	66.60	90	0.12	0.10				
9	44.30	203	0.21	0.19				
12	33.30	360	0.45	0.42				
24	16.70	1,440	1.77	1.65				

Standard Single Coil Latching Type (G6EU-134P(-ST)-US, G6EU-134C(-ST)-US)

Rated voltage (VDC)	Rated current (mA)	Coil resistance (Ω)	Coil inductance (ref. value) (H)		Set pick-up voltage	Reset pick-up voltage	Maximum voltage	Power consumption (mW)
			Armature OFF	Armature ON				
3	66.70	45	0.05	0.04	70% max.	70% min.	190% max. at 23°C	Approx. 200
5	40	125	0.13	0.12				
6	33.30	180	0.19	0.17				
9	22.20	405	0.45	0.40				
12	16.70	720	0.84	0.79				
24	8.30	2,880	3.56	3.10				

Standard Dual Coil Latching Type (G6EK-134P(-ST)-US, G6EK-134C(-ST)-US)

Rated voltage (VDC)	Rated current (mA)	Coil resistance (Ω)	Coil inductance (ref. value) (H)		Set pick-up voltage	Reset pick-up voltage	Maximum voltage	Power consumption (mW)
			Armature OFF	Armature ON				
3	66.70	45	0.05	0.04	70% max.	70% min.	190% max. at 23°C	Approx. 200
5	40	125	0.09	0.08				
6	33.30	180	0.12	0.11				
7	22.20	405	0.25	0.22				
12	16.70	720	0.44	0.41				
24	8.30	2,880	1.66	1.62				

- Note:**
1. The rated current and coil resistance are measured at a coil temperature of 23°C with a tolerance of ±10%.
 2. Operating characteristics are measured at a coil temperature of 23°C.
 3. The maximum voltage is the highest voltage that can be imposed on the relay coil.

Low-sensitivity Dual Coil Latching Type (G6EK-134PL(-ST)-US)

Rated voltage (VDC)	Rated current (mA)	Coil resistance (Ω)	Coil inductance (ref. value) (H)		Set pick-up voltage	Reset pick-up voltage	Maximum voltage	Power consumption (mW)
			Armature OFF	Armature ON				
3	133	22.50	0.02	0.01	70% max.	70% min.	170% max. at 23°C	Approx. 400
5	79.40	63	0.04	0.03				
6	66.60	90	0.06	0.04				
9	44.30	203	0.12	0.09				
12	33.30	360	0.21	0.15				
24	16.70	1,440	0.80	0.58				

- Note:** 1. The rated current and coil resistance are measured at a coil temperature of 23°C with a tolerance of $\pm 10\%$.
 2. Operating characteristics are measured at a coil temperature of 23°C.
 3. The maximum voltage is the highest voltage that can be imposed on the relay coil.

■ Characteristics

Contact resistance (See note 1)		50 m Ω max.
Operate time (set) time (See note 2)		5 ms max. (mean value approx. 2.90 ms, 48 VDC type, approx. 2.40 ms)
Release time (reset) time (See note 2)		5 ms max. (mean value approx. 1.30 ms)
Min. set/reset signal width		Latching type: 15 ms min. (at 23°C)
Operating frequency (max.)	Mechanical	36,000 operations/hour
	Electrical	1,800 operations/hour (under rated load)
Insulation resistance (See note 3)		1,000 M Ω min. (at 500 VDC)
Dielectric strength		1,500 VAC, 50/60 Hz for 1 minute between coil contacts 1,000 VAC, 50/60 Hz for 1 minute between contacts of same pole
Surge withstand voltage		1,500 V (10 x 160 μ s) (conforms to FCC Part 68) 2,500 V (2 x 10 μ s) (Telcordia Requirement)
Vibration	Mechanical durability	10 to 55 Hz; 5 mm double amplitude
	Malfunction durability	10 to 55 Hz; 3.3 mm double amplitude
Shock	Mechanical durability	1,000 m/s ² , approx. 100G
	Malfunction durability	300 m/s ² , approx. 30G
Ambient temperature		-40°C to 70°C with no icing
Humidity		5% to 85% RH
Service life	Mechanical	100 million operations min. (at 36,000 operations/hour)
	Electrical	100,000 operations min (0.4A at 125 VAC resistive; 0.2A at 125VAC inductive) 500,000 operations min. (2A at 30 VDC resistive; 1A at 30VDC inductive) 200,000 operations min. (3A at 30 VDC resistive) See "Characteristic Data"
Weight		Approx. 2.7 g

- Note:** 1. The contact resistance was measured with 1A at 5VDC with a fall-of-potential method.
 2. Values in parentheses are typical values unless otherwise stated.
 3. The insulation resistance was measured with a 500-VDC megohmmeter applied to the same parts as those for checking the dielectric strength
 4. The above values are initial values.

■ Characteristic Data

Maximum Switching Capacity

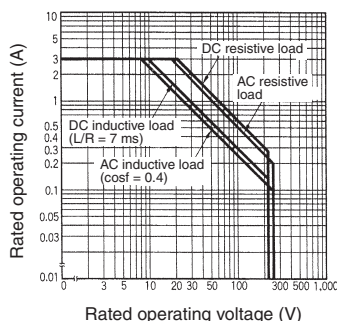

Electrical Service Life

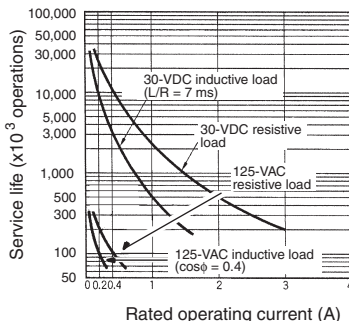

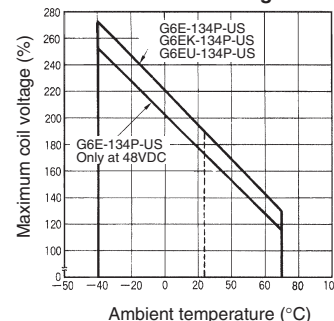

Ambient Temperature vs. Maximum Coil Voltage



Note: The maximum coil voltage refers to the maximum value in a varying range of operating power voltage, not a continuous voltage.

Dimensions

- Note:** 1. All units are in millimeters unless otherwise indicated.
 2. Orientation marks are indicated as follows:  

Standard coil

G6E-134P(L)-(ST)-US

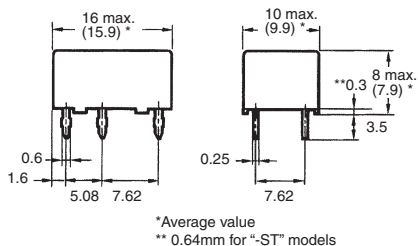
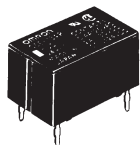

**Terminal Arrangement/
Internal Connections
(Bottom View)**

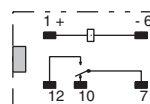

**Mounting Holes
(Bottom View)**

Tolerance: ± 0.1

G6E-134C-(ST)-US

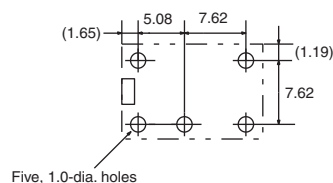
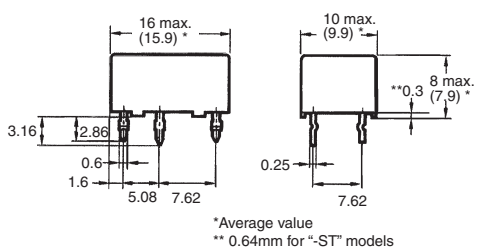
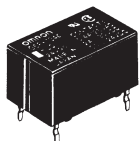

Single coil latching

G6EU-134P(L)-(ST)-US

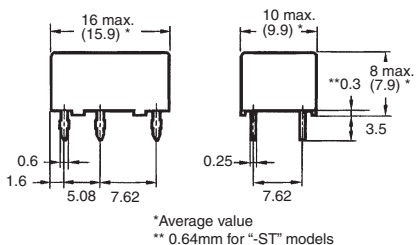
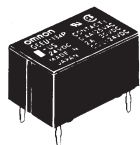

**Terminal Arrangement/
Internal Connections
(Bottom View)**

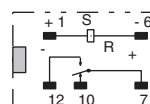

**Mounting Holes
(Bottom View)**

Tolerance: ± 0.1

G6EU-134C-(ST)-US

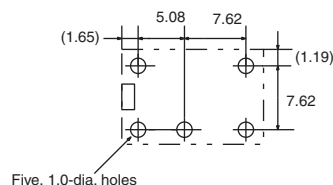
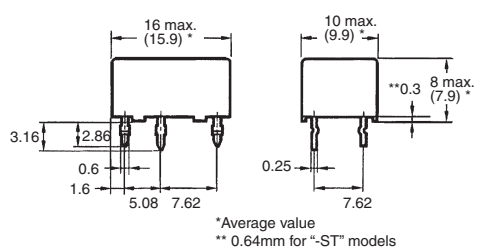
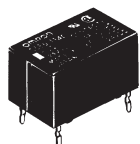

Dual coil latching

G6EK-134P(L)(-ST)-US

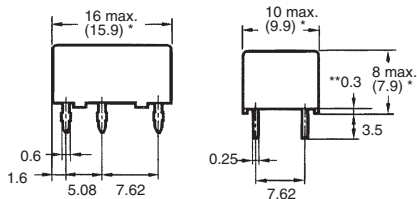
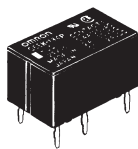

*Average value
** 0.64mm for "-ST" models

Terminal Arrangement/
Internal Connections
(Bottom View)

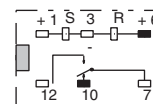

Mounting Holes
(Bottom View)

Tolerance: ±0.1

G6EK-134C(-ST)-US

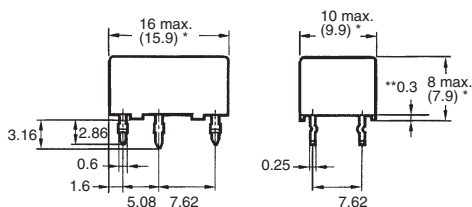
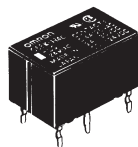

*Average value
** 0.64mm for "-ST" models

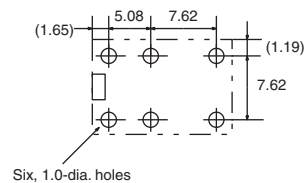

■ Approvals

UL Recognized (File No. E41515) / CSA Certified (File No. LR31928) - - Ambient Temp. = 40°C

Contact form	Coil ratings	Contact ratings	Number of test operations
SPDT	3 to 48 VDC	0.2 A at 250 VAC (General Use) 0.6 A at 125 VAC (General Use) 2 A at 30 VDC (Resistive) 0.6 A at 125 VDC (Resistive, Ag contact only)	6,000

- Note:**
1. The rated values approved by each of the safety standards (e.g., UL, CSA, TUV) may be different from the performance characteristics individually defined in this catalog.
 2. In the interest of product improvement, specifications are subject to change.

Precautions

■ Precautions for Correct Use

Long-term Continuously ON Contacts

Using the Relay in a circuit where the Relay will be ON continuously for long periods (without switching) can lead to unstable contacts because the heat generated by the coil itself will affect the insulation, causing a film to develop on the contact surfaces. We recommend using a latching relay (magnetic-holding relay) in this kind of circuit. If a single-side stable model must be used in this kind of circuit, we recommend using a fail-safe circuit design that provides protection against contact failure or coil burnout.

Installation

Do not reverse the polarity of the coil (+, -).

Provide sufficient space between Relays when mounting two or more on the same PCB, as shown in the following diagram.

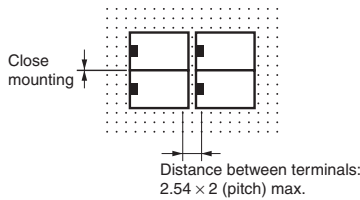

Wiring

Refer to the following diagram when wiring to switch a DC load. The difference in polarity applied to the contacts will affect the endurance of the Relay due to the amount of contact movement. To extend the endurance characteristics beyond the performance ratings, wire the common (pin 7) terminal to the positive (+) side.

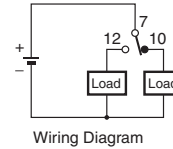

Ultrasonic Cleaning

Do not use ultrasonic cleaning on standard relay models. Doing so may result in resonance, coil burnout, and contact adhesion within the Relay.

Relay Handling

When washing the product after soldering the Relay to a PCB, use a water-based solvent or alcohol-based solvent, and keep the solvent temperature to less than 40°C. Do not put the Relay in a cold cleaning bath immediately after soldering.

■ Hints on Correct Use

Single-winding type (G6EU)

Example of low-power consumption driver circuit

1. This is an example of a driver circuit that allows Model G6E to function as a normal relay with a normal switching pulse input.
2. The relay is set by an abrupt current charged to capacity C. This current flows in the relay via diode D₁ and C and out via diode D₂.
3. The relay is reset by the discharge current of C flowing in the relay via transistor TR and C.

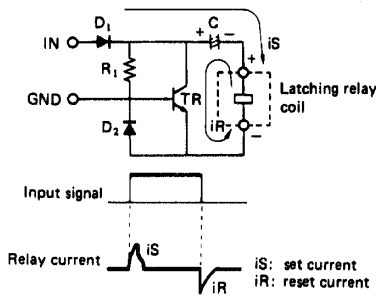

- Note:**
1. Give adequate consideration to the circuit constant when actually using this circuit, confirming the set and reset status of the relay.
 2. OMRON owns the patent on this circuit. Consult OMRON when using this circuit.



All sales are subject to Omron Electronic Components LLC standard terms and conditions of sale, which can be found at http://www.components.omron.com/components/web/webfiles.nsf/sales_terms.html

ALL DIMENSIONS SHOWN ARE IN MILLIMETERS.

To convert millimeters into inches, multiply by 0.03937. To convert grams into ounces, multiply by 0.03527.

OMRON[®]

**OMRON ELECTRONIC
COMPONENTS LLC**

55 E. Commerce Drive, Suite B
Schaumburg, IL 60173

847-882-2288

OMRON ON-LINE

Global - <http://www.omron.com>

USA - <http://www.components.omron.com>

Cat. No. X301-E-1b

09/11

Specifications subject to change without notice

Printed in USA

Mouser Electronics

Authorized Distributor

Click to View Pricing, Inventory, Delivery & Lifecycle Information:

Omron:

[G6E-134P-L-ST-US-DC5](#) [G6E-134P-ST-US-DC12](#) [G6E-134P-L-ST-US-DC12](#) [G6E-134P-L-ST-US-DC24](#) [G6EK-134P-ST-US-DC24](#) [G6EK-134P-ST-US-DC12](#) [G6EK-134P-ST-US-DC5](#) [G6E-134P-ST-US-DC9](#) [G6E-134P-ST-US-DC5](#) [G6E-134P-ST-US-DC24](#) [G6E-134P-ST-US-DC6](#) [G6E-134PL-ST-US-DC9](#) [G6EU-134P-ST-US-DC3](#) [G6EU-134P-ST-US-DC5](#) [G6EU-134P-ST-US-DC6](#) [G6EU-134P-ST-US-DC9](#) [G6EU-134P-ST-US-DC12](#) [G6EU-134P-ST-US-DC24](#) [G6EK-134P-ST-US-DC3](#) [G6EK-134P-ST-US-DC6](#) [G6EK-134P-ST-US-DC9](#) [G6EK-134PL-ST-US-DC3](#) [G6EK-134PL-ST-US-DC5](#) [G6EK-134PL-ST-US-DC6](#) [G6EK-134PL-ST-US-DC12](#) [G6EK-134PL-ST-US-DC24](#) [G6E-134PL-US-DC48](#) [G6E-134P-ST-US-H-DC48](#) [G6EK-134P-ST-US DC1.5](#) [G6EU-134PL-ST-US-DC12](#) [G6EU-134PL-ST-US-DC24](#) [G6EU-134PL-ST-US-DC5](#) [G6E-134P-ST-US DC3](#) [G6E-134P-ST-US-DC48](#) [G6E-134P-US DC48](#) [G6E-134P-US DC5](#) [G6E-134PL-ST-US DC3](#) [G6E-134P-US DC24](#) [G6E-134P-US DC12](#)